

**Tip: Semi-hermetic pistonlu kompresörler****Üretici: Copeland****Seri: DL****Model: DLSG-40 X****Teknik Bilgi**

Piston Sayısı:	2
Süpürme Hacmi [m <sup>3</sup> /h]:	22,5
Ağırlık [kg]:	88
Yağ Yüğü [dm <sup>3</sup> ]:	2,3
Maksimum Çalışma Akımı [A]:	8,9
Kilitli Rotor Akımı [A]:	68,5
Güç Kaynağı [V/~/Hz]:	380-420V/3/50Hz

**Bağlantılar**

	milimetre	inç
Emme Hattı:		1 1/8"
Basma Hattı:		5/8"

R22

**Soğutma Kapasitesi [kW]**

$t_c \setminus t_e$	-50	-45	-40	-35	-30	-25	-20
25	1.14	1.94	3.02	4.36	5.92	7.67	9.59
30	0.94	1.68	2.69	3.96	5.44	7.12	8.96
35	0.77	1.43	2.37	3.56	4.97	6.57	8.33
40	0.61	1.20	2.07	3.18	4.51	6.03	7.71
45	-	-	1.78	2.81	4.06	5.50	7.09
50	-	-	-	2.46	3.63	4.98	6.48
55	-	-	-	2.12	3.20	4.47	5.88

**Güç Girişi [kW]**

$t_c \setminus t_e$	-50	-45	-40	-35	-30	-25	-20
25	1.55	1.87	2.22	2.58	2.91	3.21	3.44
30	1.53	1.87	2.25	2.64	3.02	3.36	3.65
35	1.49	1.86	2.27	2.69	3.11	3.50	3.84
40	1.44	1.83	2.27	2.73	3.19	3.62	4.01
45	-	-	2.26	2.75	3.25	3.72	4.16
50	-	-	-	2.77	3.29	3.81	4.29
55	-	-	-	2.76	3.33	3.88	4.41

**Akım [A]**

$t_c \setminus t_e$	-50	-45	-40	-35	-30	-25	-20
25	4.29	4.58	4.92	5.29	5.67	6.01	6.30
30	4.27	4.57	4.95	5.36	5.79	6.20	6.57
35	4.24	4.56	4.96	5.42	5.89	6.37	6.82
40	4.20	4.54	4.97	5.46	5.99	6.53	7.05
45	-	-	4.96	5.49	6.06	6.66	7.26
50	-	-	-	5.50	6.12	6.78	7.45
55	-	-	-	5.50	6.17	6.88	7.61



**Kütlesel Debi [kg/s]**

$t_c \setminus t_e$	-50	-45	-40	-35	-30	-25	-20
25	25.65	42.98	66.04	93.99	125.94	161.05	198.44
30	22.22	38.76	61.18	88.61	120.19	155.05	192.33
35	18.85	34.56	56.28	83.14	114.29	148.86	185.98
40	15.53	30.35	51.31	77.57	108.24	142.46	179.37
45	-	-	46.28	71.87	102.01	135.84	172.49
50	-	-	-	66.04	95.60	128.98	165.32
55	-	-	-	60.06	88.99	121.87	157.85

**Performans Katsayısı [W/W]**

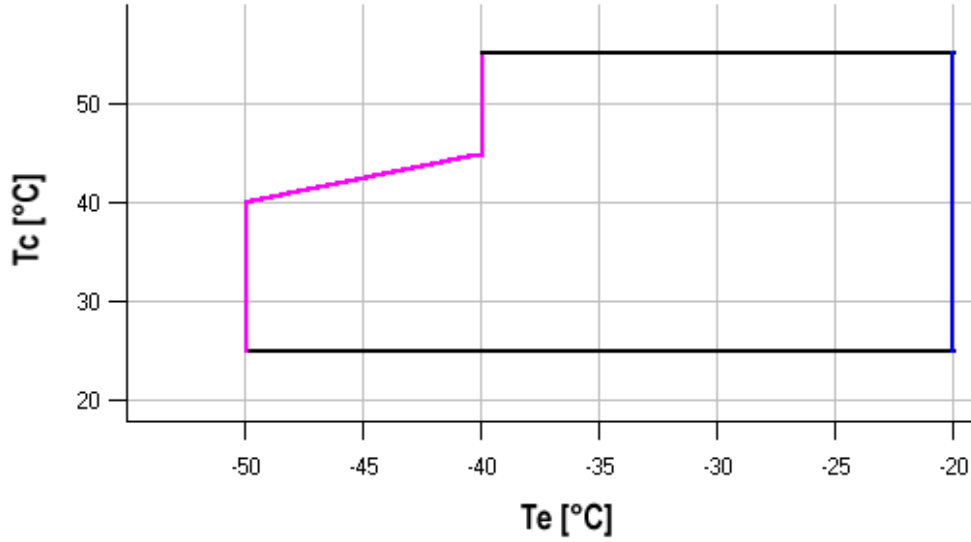
$t_c \setminus t_e$	-50	-45	-40	-35	-30	-25	-20
25	0.73	1.03	1.36	1.69	2.03	2.39	2.79
30	0.62	0.90	1.20	1.50	1.80	2.12	2.46
35	0.52	0.77	1.05	1.32	1.60	1.88	2.17
40	0.42	0.65	0.91	1.17	1.42	1.67	1.92
45	-	-	0.79	1.02	1.25	1.48	1.70
50	-	-	-	0.89	1.10	1.31	1.51
55	-	-	-	0.77	0.96	1.15	1.33

**Uygulama Aralığı**

 Maksimum Buharlaşma Sıcaklığı  
 25°C emiş gazı dönüşü + ilave soğutma

Çalışma Koşulları: ISO; aşırı soğutma: 0 K, emme kızdırması: 10 K, dönüş gazı sıcaklığı: -

$t_c$  - Yoğuşma Sıcaklığı [°C]

$t_e$  - Buharlaşma Sıcaklığı [°C]

R134a

**Soğutma Kapasitesi [kW]**

<b>t<sub>c</sub> \ t<sub>e</sub></b>	<b>-20</b>	<b>-15</b>	<b>-10</b>	<b>-5</b>	<b>0</b>	<b>5</b>	<b>10</b>
<b>30</b>	4.75	6.24	8.02	10.12	12.60	15.49	18.84
<b>35</b>	4.30	5.73	7.42	9.42	11.78	14.53	17.73
<b>40</b>	3.87	5.23	6.83	8.72	10.96	13.57	16.61
<b>45</b>	3.46	4.74	6.25	8.03	10.14	12.61	15.49
<b>50</b>	3.06	4.26	5.68	7.35	9.33	11.66	14.37
<b>55</b>	2.68	3.80	5.12	6.68	8.53	10.70	13.25
<b>60</b>	2.32	3.36	4.58	6.02	7.73	9.75	12.13

**Güç Girişi [kW]**

<b>t<sub>c</sub> \ t<sub>e</sub></b>	<b>-20</b>	<b>-15</b>	<b>-10</b>	<b>-5</b>	<b>0</b>	<b>5</b>	<b>10</b>
<b>30</b>	2.14	2.37	2.60	2.80	2.97	3.10	3.18
<b>35</b>	2.21	2.48	2.74	2.98	3.20	3.38	3.53
<b>40</b>	2.28	2.57	2.87	3.15	3.42	3.65	3.85
<b>45</b>	2.34	2.66	2.99	3.31	3.62	3.90	4.16
<b>50</b>	2.39	2.74	3.10	3.46	3.81	4.14	4.44
<b>55</b>	2.44	2.81	3.20	3.59	3.98	4.35	4.71
<b>60</b>	2.48	2.87	3.28	3.70	4.13	4.55	4.95

**Akım[A]**

<b>t<sub>c</sub> \ t<sub>e</sub></b>	<b>-20</b>	<b>-15</b>	<b>-10</b>	<b>-5</b>	<b>0</b>	<b>5</b>	<b>10</b>
<b>30</b>	4.92	5.19	5.45	5.69	5.90	6.06	6.16
<b>35</b>	5.00	5.31	5.62	5.92	6.19	6.42	6.60
<b>40</b>	5.08	5.42	5.78	6.13	6.46	6.76	7.02
<b>45</b>	5.15	5.53	5.92	6.33	6.72	7.09	7.42
<b>50</b>	5.21	5.62	6.06	6.51	6.96	7.39	7.80
<b>55</b>	5.27	5.71	6.18	6.68	7.18	7.68	8.15
<b>60</b>	5.31	5.78	6.29	6.83	7.38	7.94	8.48

**Kütlesel Debi [kg/s]**

<b>t<sub>c</sub> \ t<sub>e</sub></b>	<b>-20</b>	<b>-15</b>	<b>-10</b>	<b>-5</b>	<b>0</b>	<b>5</b>	<b>10</b>
<b>30</b>	112.25	144.66	181.99	224.98	274.38	330.96	395.45
<b>35</b>	106.86	139.27	176.51	219.33	268.48	324.70	388.76
<b>40</b>	101.43	133.78	170.87	213.45	262.26	318.07	381.61
<b>45</b>	95.95	128.17	165.04	207.30	255.72	311.03	374.00
<b>50</b>	90.41	122.42	159.00	200.89	248.83	303.58	365.89
<b>55</b>	84.78	116.52	152.74	194.17	241.57	295.70	357.29
<b>60</b>	79.05	110.45	146.24	187.15	233.94	287.36	348.17

**Performans Katsayısı [W/W]**

$t_c \setminus t_e$	-20	-15	-10	-5	0	5	10
30	2.22	2.63	3.09	3.62	4.25	5.00	5.92
35	1.95	2.31	2.71	3.16	3.68	4.30	5.03
40	1.70	2.03	2.38	2.77	3.21	3.72	4.31
45	1.48	1.78	2.09	2.43	2.80	3.23	3.73
50	1.28	1.55	1.83	2.13	2.45	2.82	3.23
55	1.10	1.35	1.60	1.86	2.14	2.46	2.81
60	0.94	1.17	1.40	1.63	1.87	2.15	2.45

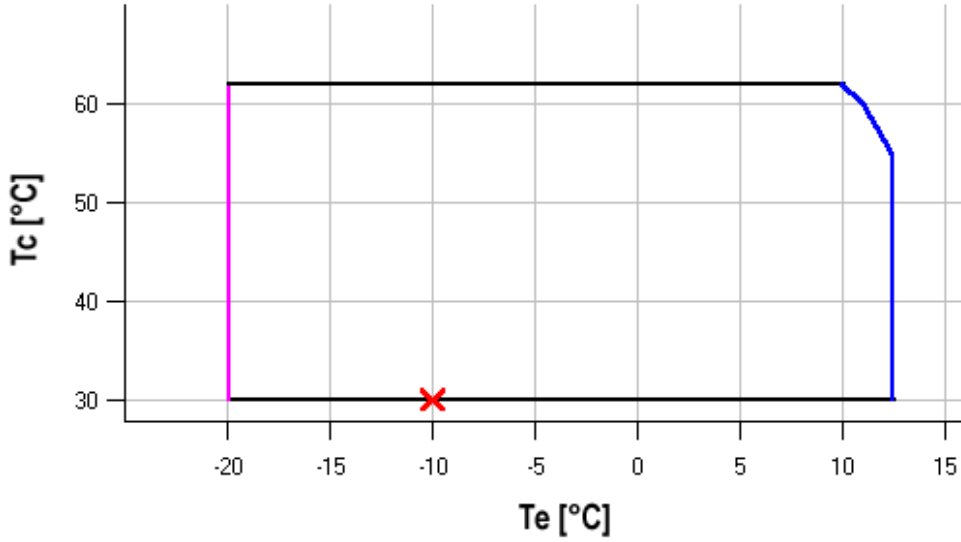
**Uygulama Aralığı**

**Blue** Maksimum Buharlaşma Sıcaklığı  
**Pink** 25°C emiş gazı dönüşü + ilave soğutma

Çalışma Koşulları: ISO; aşırı soğutma: 0 K, emme kızdırması: 10 K, dönüş gazı sıcaklığı: -

$t_c$  - Yoğuşma Sıcaklığı [°C]

$t_e$  - Buharlaşma Sıcaklığı [°C]

R404A/R507

**Soğutma Kapasitesi [kW]**

<b>t<sub>c</sub> \ t<sub>e</sub></b>	<b>-50</b>	<b>-45</b>	<b>-40</b>	<b>-35</b>	<b>-30</b>	<b>-25</b>	<b>-20</b>
<b>25</b>	1.62	2.55	3.68	5.05	6.67	8.58	10.80
<b>30</b>	1.28	2.17	3.24	4.52	6.05	7.85	9.94
<b>35</b>	0.96	1.79	2.80	4.00	5.43	7.11	9.07
<b>40</b>	-	1.42	2.36	3.48	4.80	6.36	8.19
<b>45</b>	-	-	1.93	2.96	4.18	5.62	7.30
<b>50</b>	-	-	1.52	2.46	3.57	4.88	6.42
<b>55</b>	-	-	-	1.97	2.97	4.15	5.54

**Güç Girişi [kW]**

<b>t<sub>c</sub> \ t<sub>e</sub></b>	<b>-50</b>	<b>-45</b>	<b>-40</b>	<b>-35</b>	<b>-30</b>	<b>-25</b>	<b>-20</b>
<b>25</b>	1.48	1.84	2.21	2.57	2.94	3.29	3.62
<b>30</b>	1.40	1.78	2.19	2.60	3.01	3.41	3.80
<b>35</b>	1.28	1.71	2.14	2.60	3.06	3.52	3.97
<b>40</b>	-	1.60	2.08	2.57	3.08	3.60	4.11
<b>45</b>	-	-	1.99	2.53	3.08	3.65	4.22
<b>50</b>	-	-	1.87	2.45	3.06	3.68	4.31
<b>55</b>	-	-	-	2.35	3.01	3.68	4.37



**Akım [A]**

<b>t<sub>c</sub> \ t<sub>e</sub></b>	<b>-50</b>	<b>-45</b>	<b>-40</b>	<b>-35</b>	<b>-30</b>	<b>-25</b>	<b>-20</b>
<b>25</b>	4.08	4.53	5.01	5.51	6.01	6.51	6.99
<b>30</b>	3.97	4.46	4.98	5.53	6.10	6.68	7.27
<b>35</b>	3.84	4.36	4.92	5.53	6.17	6.83	7.51
<b>40</b>	-	4.23	4.84	5.50	6.21	6.95	7.73
<b>45</b>	-	-	4.72	5.43	6.21	7.04	7.91
<b>50</b>	-	-	4.56	5.33	6.18	7.08	8.05
<b>55</b>	-	-	-	5.19	6.10	7.09	8.14



**Kütlesel Debi [kg/s]**

<b>t<sub>c</sub> \ t<sub>e</sub></b>	<b>-50</b>	<b>-45</b>	<b>-40</b>	<b>-35</b>	<b>-30</b>	<b>-25</b>	<b>-20</b>
<b>25</b>	36.79	58.44	84.64	116.26	154.17	199.24	252.35
<b>30</b>	30.75	52.25	78.23	109.57	147.15	191.84	244.50
<b>35</b>	24.34	45.60	71.29	102.29	139.46	183.67	235.81
<b>40</b>	-	38.50	63.82	94.39	131.08	174.75	226.28
<b>45</b>	-	-	55.83	85.89	122.01	165.06	215.91
<b>50</b>	-	-	47.30	76.77	112.25	154.60	204.69
<b>55</b>	-	-	-	67.05	101.80	143.37	192.62

**Performans Katsayısı [W/W]**

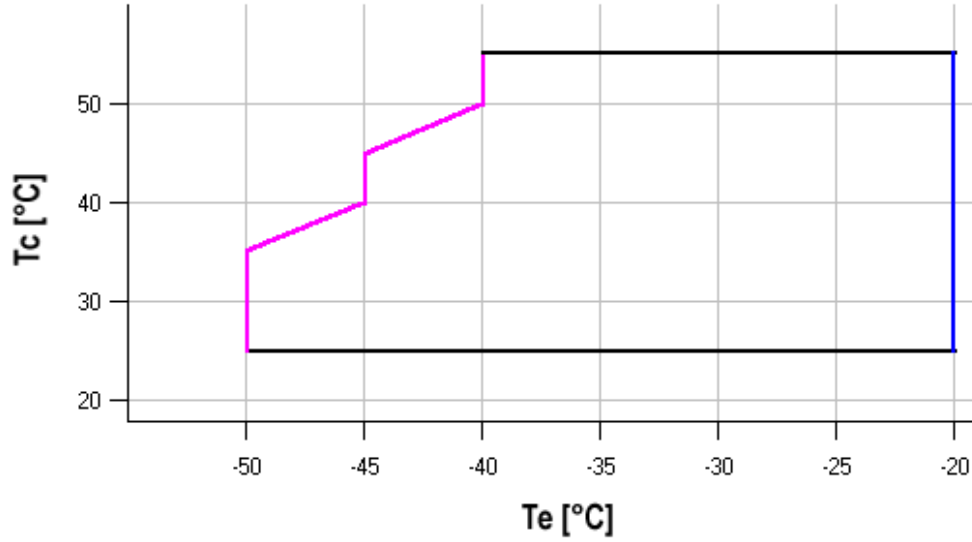
$t_c \setminus t_e$	-50	-45	-40	-35	-30	-25	-20
25	1.09	1.38	1.67	1.96	2.27	2.61	2.98
30	0.92	1.21	1.48	1.74	2.01	2.30	2.61
35	0.74	1.05	1.30	1.54	1.78	2.02	2.29
40	-	0.89	1.14	1.35	1.56	1.77	1.99
45	-	-	0.97	1.17	1.36	1.54	1.73
50	-	-	0.81	1.00	1.17	1.33	1.49
55	-	-	-	0.84	0.99	1.13	1.27

**Uygulama Aralığı**

 Maksimum Buharlaşma Sıcaklığı  
 25°C emiş gazı dönüşü + ilave soğutma

Çalışma Koşulları: ISO; aşırı soğutma: 0 K, emme kızdırması: - K, dönüş gazı sıcaklığı: 20

$t_c$  - Yoğuşma Sıcaklığı [°C]

$t_e$  - Buharlaşma Sıcaklığı [°C]

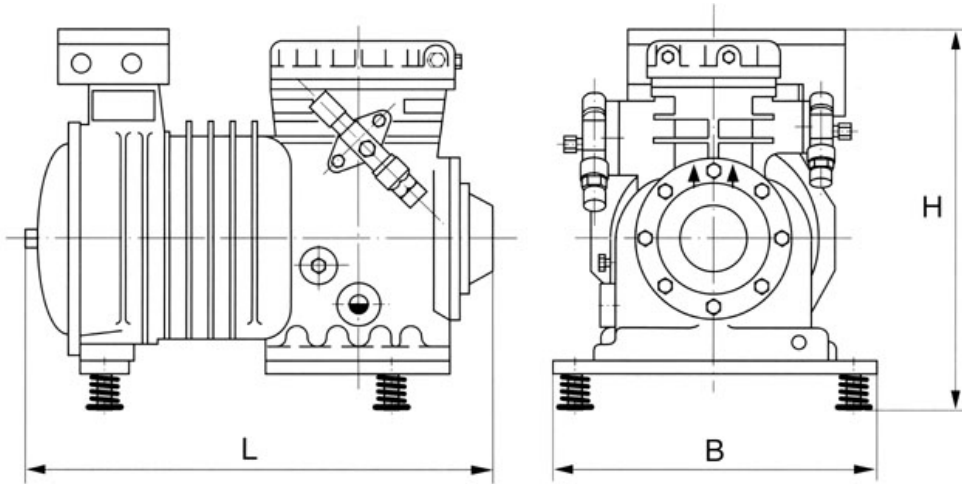

L	470 mm
B	330 mm
H	385 mm

